

Low-Noise, Low Quiescent Current, Precision Operational Amplifier *e-trim*[™] Series

Check for Samples: [OPA376-Q1](#), [OPA2376-Q1](#), [OPA4376-Q1](#)

FEATURES

- Qualified for Automotive Applications
- Low Noise: $7.5\text{nV}/\sqrt{\text{Hz}}$ at 1kHz
- 0.1Hz TO 10Hz Noise: $0.8\mu\text{V}_{\text{PP}}$
- Quiescent Current: $760\mu\text{V}$ (typ)
- Low Offset Voltage: $5\mu\text{V}$ (typ)
- Gain Bandwidth Product: 5.5MHz
- Rail-to-Rail Output
- Single-Supply Operation
- Supply Voltage: 2.2V to 5.5V
- Space-Saving Packages:
 - SC-70, SOT23, MSOP, TSSOP

APPLICATIONS

- ADC Buffer
- Audio Equipment
- Medical Instrumentation
- Handheld Test Equipment
- Active Filtering
- Sensor Signal Conditioning

DESCRIPTION

The OPA376-Q1 family represent a new generation of low-noise operational amplifiers with *e-trim*, offering outstanding dc precision and ac performance. Rail-to-rail output, low offset ($25\mu\text{V}$ max), low noise ($7.5\text{nV}/\sqrt{\text{Hz}}$), quiescent current of $950\mu\text{A}$ max, and a 5.5MHz bandwidth make this part very attractive for a variety of precision and portable applications. In addition, this device has a reasonably wide supply range with excellent PSRR, making it attractive for applications that run directly from batteries without regulation.

The OPA376-Q1 (single version) is available in MicroSIZE SC70-5, SOT23-5, and SO-8 packages. The OPA2376-Q1 (dual) is offered in the SO-8 package. The OPA4376-Q1 (quad) is offered in a TSSOP-14 package. All versions are specified for operation from -40°C to 125°C .

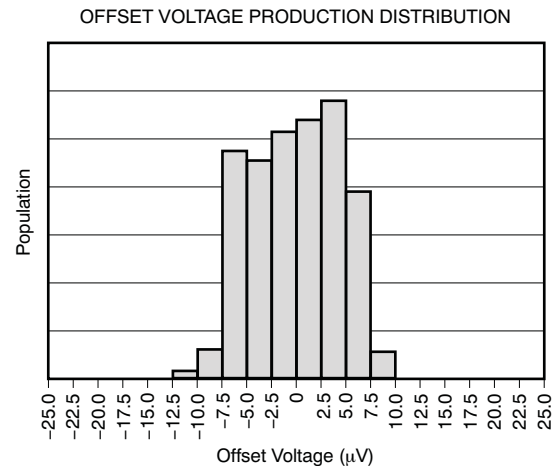
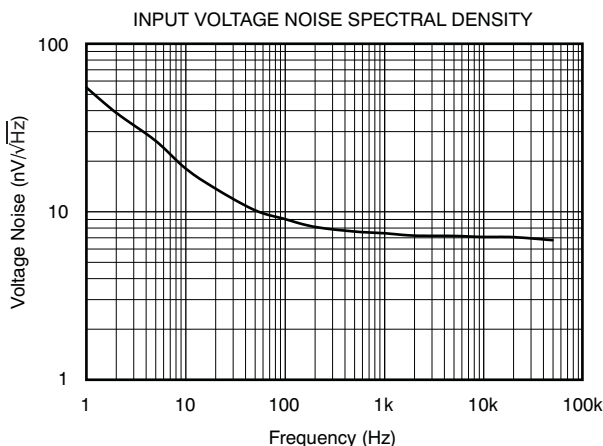

Please be aware that an important notice concerning availability, standard warranty, and use in critical applications of Texas Instruments semiconductor products and disclaimers thereto appears at the end of this data sheet.

e-trim is a trademark of Texas Instruments Incorporated.
All other trademarks are the property of their respective owners.



This integrated circuit can be damaged by ESD. Texas Instruments recommends that all integrated circuits be handled with appropriate precautions. Failure to observe proper handling and installation procedures can cause damage.

ESD damage can range from subtle performance degradation to complete device failure. Precision integrated circuits may be more susceptible to damage because very small parametric changes could cause the device not to meet its published specifications.

ABSOLUTE MAXIMUM RATING⁽¹⁾

over operating free-air temperature range (unless otherwise noted)

		VALUE	UNIT
Supply voltage	$V_S = (V+) - (V-)$	+7	V
Signal input terminals	Voltage ⁽²⁾	(V-) – 0.5 to (V+) + 0.5	V
	Current ⁽²⁾	±10	mA
Output short-circuit ⁽³⁾		Continuous	
Operating temperature	T_A	–40 to +125	°C
Storage temperature	T_A	–65 to +150	°C
Junction temperature	T_J	+150	°C

- (1) Stresses above these ratings may cause permanent damage. Exposure to absolute maximum conditions for extended periods may degrade device reliability. These are stress ratings only, and functional operation of the device at these or any other conditions beyond those specified is not supported.
- (2) Input terminals are diode-clamped to the power-supply rails. Input signals that can swing more than 0.5V beyond the supply rails should be current limited to 10mA or less.
- (3) Short-circuit to ground, one amplifier per package.

PACKAGE INFORMATION⁽¹⁾

PRODUCT	PACKAGE-LEAD	PACKAGE DESIGNATOR	PACKAGE MARKING
OPA376-Q1	SC70-5	DCK	Preview
	SOT23-5	DBV	OUHQ
	SO-8	D	Preview
OPA2376-Q1	SO-8	D	Preview
	MSOP-8	DGK	Preview
OPA4376-Q1	TSSOP-14	PW	Preview

- (1) For the most current package and ordering information, see the Package Option Addendum at the end of this document, or visit the device product folder at www.ti.com.

ELECTRICAL CHARACTERISTICS: $V_S = +2.2V$ to $+5.5V$
Boldface limits apply over the specified temperature range: $T_A = -40^\circ\text{C}$ to $+125^\circ\text{C}$.

At $T_A = +25^\circ\text{C}$, $R_L = 10\text{k}\Omega$ connected to $V_S/2$, $V_{CM} = V_S/2$, and $V_{O\text{UT}} = V_S/2$, unless otherwise noted.

PARAMETERS	CONDITIONS	MIN	TYP	MAX	UNIT
OFFSET VOLTAGE					
Input Offset Voltage	V_{OS}		5	25	μV
vs Temperature	dV_{OS}/dT	-40°C to $+85^\circ\text{C}$	0.26	1	$\mu\text{V}/^\circ\text{C}$
		-40°C to $+125^\circ\text{C}$	0.32	2	$\mu\text{V}/^\circ\text{C}$
vs Power Supply	PSRR	$V_S = +2.2V$ to $+5.5V$, $V_{CM} < (V+) - 1.3V$	5	20	$\mu\text{V}/V$
Over Temperature		$V_S = +2.2V$ to $+5.5V$, $V_{CM} < (V+) - 1.3V$	5		$\mu\text{V}/V$
Channel Separation, dc (dual, quad)			0.5		mV/V
INPUT BIAS CURRENT					
Input Bias Current	I_B		0.2	10	pA
Over Temperature			See Typical Characteristics		pA
Input Offset Current	I_{OS}		0.2	10	pA
NOISE					
Input Voltage Noise, $f = 0.1\text{Hz}$ to 10Hz			0.8		μV_{PP}
Input Voltage Noise Density, $f = 1\text{kHz}$	e_n		7.5		$\text{nV}/\sqrt{\text{Hz}}$
Input Current Noise, $f = 1\text{kHz}$	i_n		2		$\text{fA}/\sqrt{\text{Hz}}$
INPUT VOLTAGE RANGE					
Common-Mode Voltage Range	V_{CM}		$(V-) - 0.1$	$(V+) + 0.1$	V
Common-Mode Rejection Ratio	CMRR	$(V-) < V_{CM} < (V+) - 1.3\text{V}$	76	90	dB
INPUT CAPACITANCE					
Differential			6.5		pF
Common-Mode			13		pF
OPEN-LOOP GAIN					
Open-Loop Voltage Gain	A_{OL}	$50\text{mV} < V_O < (V+) - 50\text{mV}$, $R_L = 10\text{k}\Omega$	120	134	dB
		$100\text{mV} < V_O < (V+) - 100\text{mV}$, $R_L = 2\text{k}\Omega$	120	126	dB
FREQUENCY RESPONSE $C_L = 100\text{pF}$, $V_S = 5.5V$					
Gain-Bandwidth Product	GBW		5.5		MHz
Slew Rate	SR	$G = +1$	2		$\text{V}/\mu\text{s}$
Settling Time 0.1%	t_s	$2V$ Step, $G = +1$	1.6		μs
Settling Time 0.01%	t_s	$2V$ Step, $G = +1$	2		μs
Overload Recovery Time		$V_{IN} \times \text{Gain} > V_S$	0.33		μs
THD + Noise	THD+N	$V_O = 1V_{RMS}$, $G = +1$, $f = 1\text{kHz}$, $R_L = 10\text{k}\Omega$	0.00027		$\%$
OUTPUT					
Voltage Output Swing from Rail		$R_L = 10\text{k}\Omega^{(1)}$	10	20	mV
		$R_L = 10\text{k}\Omega^{(2)}$	20	30	mV
Over Temperature		$R_L = 10\text{k}\Omega$		40	mV
Voltage Output Swing from Rail		$R_L = 2\text{k}\Omega^{(1)}$	40	50	mV
		$R_L = 2\text{k}\Omega^{(2)}$	50	60	mV
Over Temperature		$R_L = 2\text{k}\Omega$		80	mV
Short-Circuit Current	I_{SC}		+30/-50		mA
Capacitive Load Drive	C_{LOAD}		See Typical Characteristics		
Open-Loop Output Impedance	R_O		150		Ω

(1) SC70-5, SOT23-5, SO-8, MSOP-8, and TSSOP-14 packages only.

(2) Wafer chip-scale package only.

ELECTRICAL CHARACTERISTICS: $V_S = +2.2V$ to $+5.5V$ (continued)

Boldface limits apply over the specified temperature range: $T_A = -40^{\circ}C$ to $+125^{\circ}C$.

At $T_A = +25^{\circ}C$, $R_L = 10k\Omega$ connected to $V_S/2$, $V_{CM} = V_S/2$, and $V_{O UT} = V_S/2$, unless otherwise noted.

PARAMETERS	CONDITIONS	MIN	TYP	MAX	UNIT
POWER SUPPLY					
Specified Voltage Range	V_S	2.2		5.5	V
Operating Voltage Range			2 to 5.5		V
Quiescent Current per amplifier	I_Q $I_O = 0, V_S = +5.5V, V_{CM} < (V+) - 1.3V$		760	950	μA
Over Temperature				1	mA
TEMPERATURE RANGE					
Specified Range		-40		+125	$^{\circ}C$
Operating Range		-40		+150	$^{\circ}C$
Thermal Resistance	θ_{JA}				$^{\circ}C/W$
SC70			250		$^{\circ}C/W$
SOT23			200		$^{\circ}C/W$
SO-8, TSSOP-14, MSOP-8			150		$^{\circ}C/W$

PIN CONFIGURATIONS

**OPA376-Q1
SOT23-5
(TOP VIEW)**

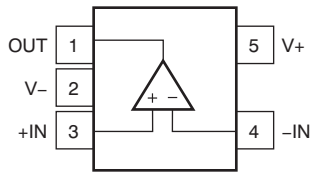

**OPA376-Q1
SC70-5
(TOP VIEW)**

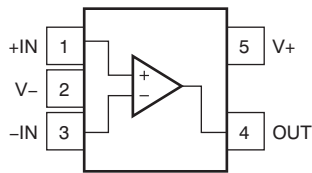

**OPA376-Q1
SO-8
(TOP VIEW)**

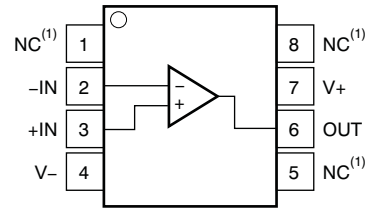

**OPA2376-Q1
SO-8, MSOP-8
(TOP VIEW)**

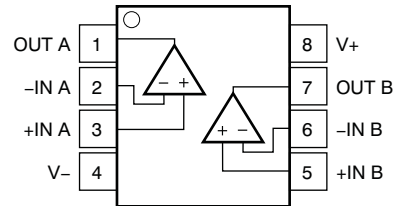

**OPA4376-Q1
TSSOP-14
(TOP VIEW)**

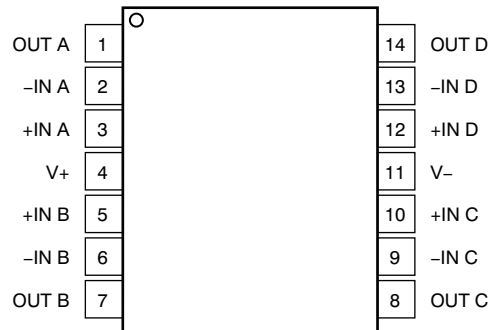

NOTE: (1) NC denotes no internal connection.

TYPICAL CHARACTERISTICS

At $T_A = +25^\circ\text{C}$, $V_S = +5\text{V}$, $R_L = 10\text{k}\Omega$ connected to $V_S/2$, $V_{CM} = V_S/2$, and $V_{OUT} = V_S/2$, unless otherwise noted.

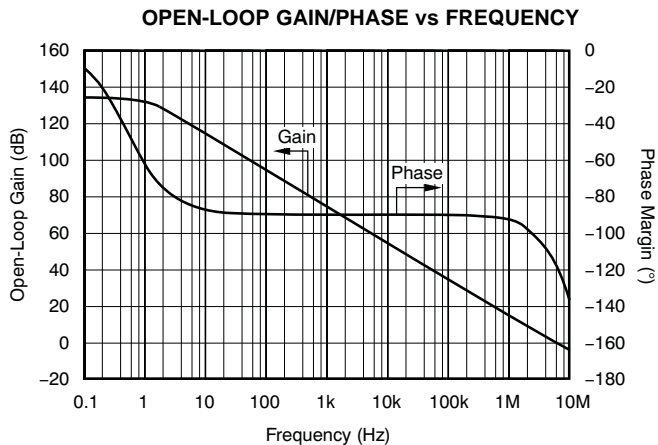

Figure 1.

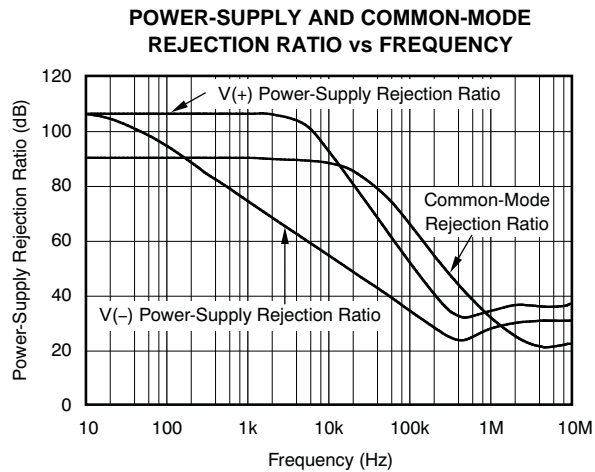

Figure 2.

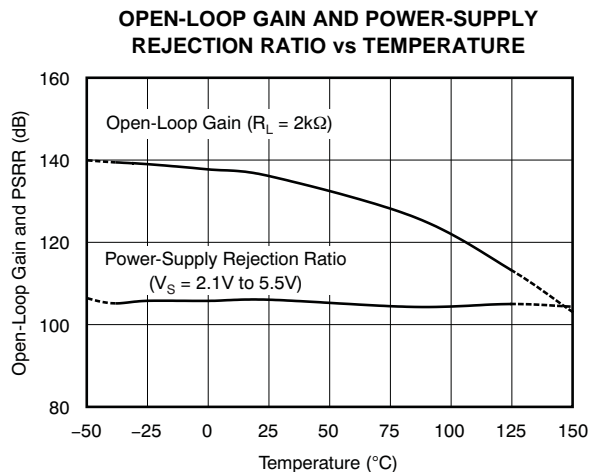

Figure 3.

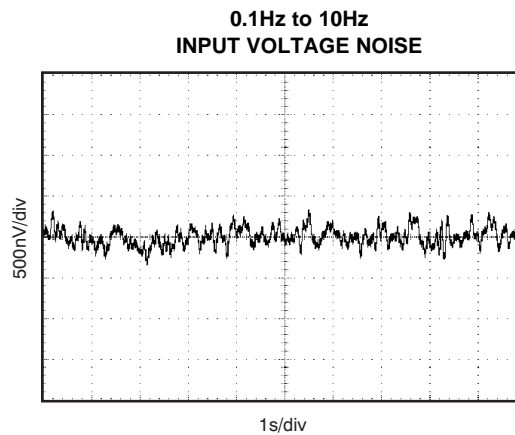

Figure 4.

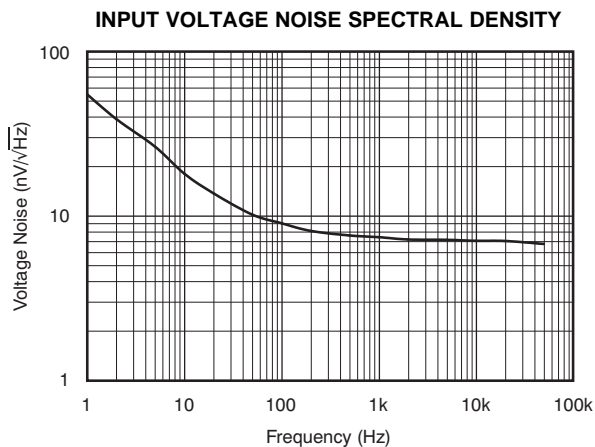

Figure 5.

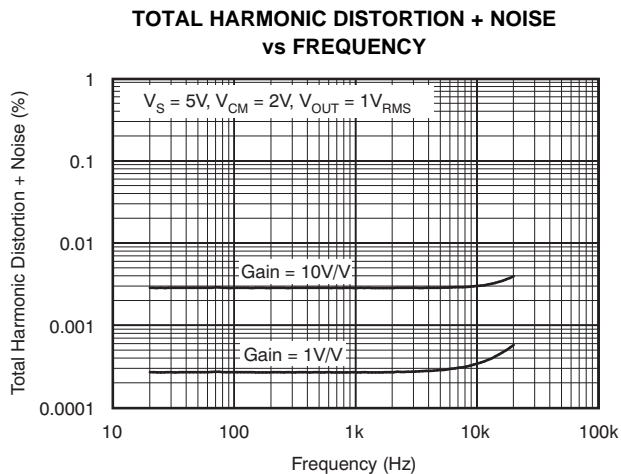

Figure 6.

TYPICAL CHARACTERISTICS (continued)

At $T_A = +25^\circ\text{C}$, $V_S = +5\text{V}$, $R_L = 10\text{k}\Omega$ connected to $V_S/2$, $V_{CM} = V_S/2$, and $V_{OUT} = V_S/2$, unless otherwise noted.

COMMON-MODE REJECTION RATIO vs TEMPERATURE

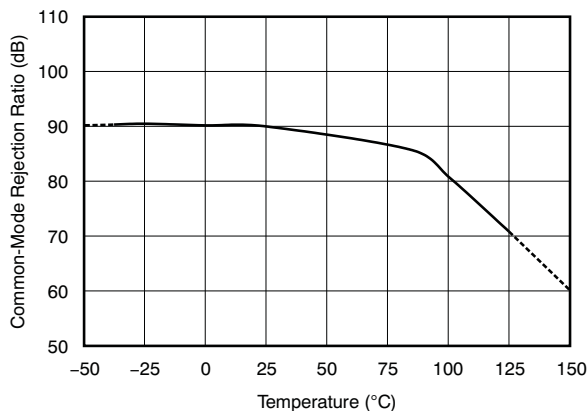

Figure 7.

QUIESCENT CURRENT vs TEMPERATURE

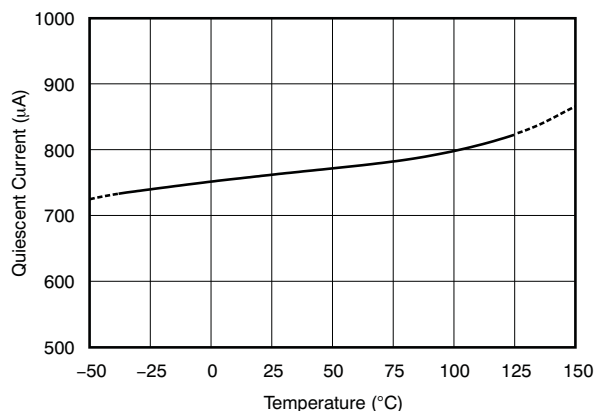

Figure 8.

QUIESCENT AND SHORT-CIRCUIT CURRENT vs SUPPLY VOLTAGE

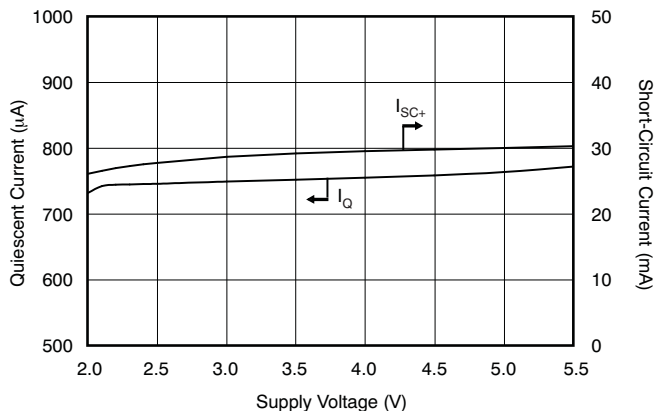

Figure 9.

SHORT-CIRCUIT CURRENT vs TEMPERATURE

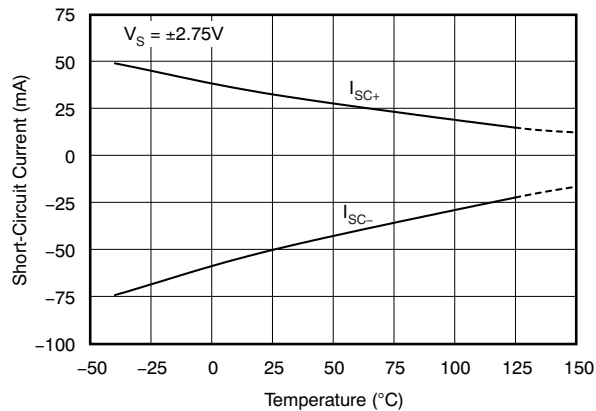

Figure 10.

INPUT BIAS CURRENT vs TEMPERATURE

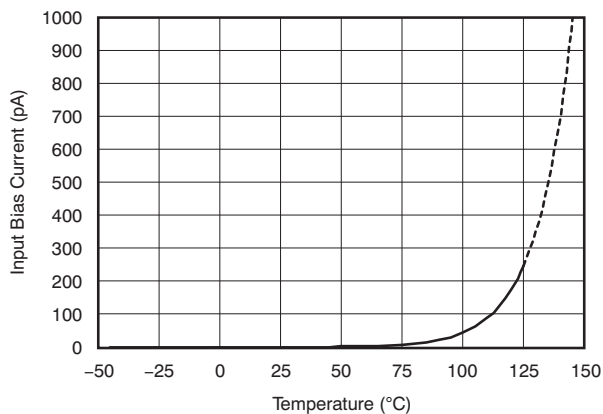

Figure 11.

OUTPUT VOLTAGE vs OUTPUT CURRENT

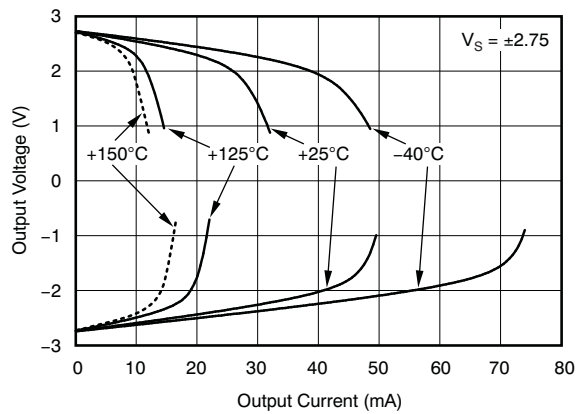

Figure 12.

TYPICAL CHARACTERISTICS (continued)

At $T_A = +25^\circ\text{C}$, $V_S = +5\text{V}$, $R_L = 10\text{k}\Omega$ connected to $V_S/2$, $V_{CM} = V_S/2$, and $V_{O_{UT}} = V_S/2$, unless otherwise noted.

**OFFSET VOLTAGE
PRODUCTION DISTRIBUTION**

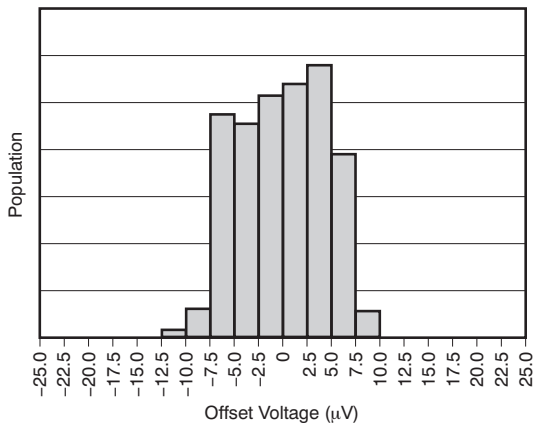

Figure 13.

**OFFSET VOLTAGE DRIFT
PRODUCTION DISTRIBUTION
(-40°C to $+125^\circ\text{C}$)**

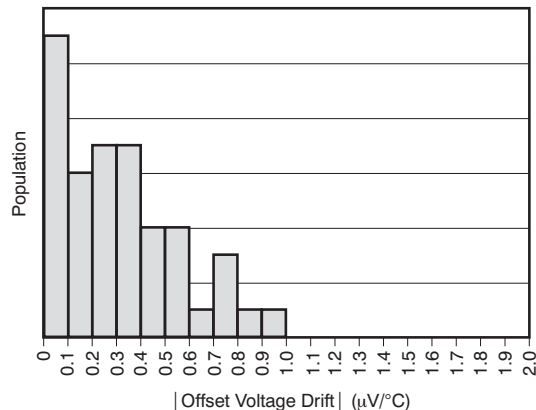

Figure 14.

MAXIMUM OUTPUT VOLTAGE vs FREQUENCY

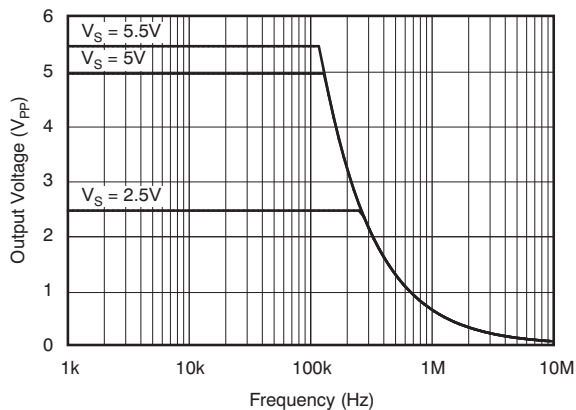

Figure 15.

SMALL-SIGNAL OVERSHOOT vs LOAD CAPACITANCE

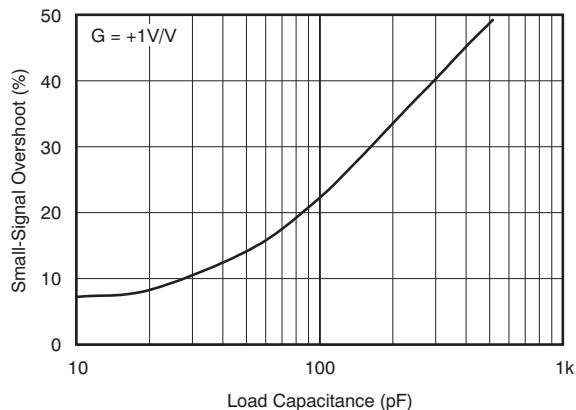

Figure 16.

SMALL-SIGNAL PULSE RESPONSE

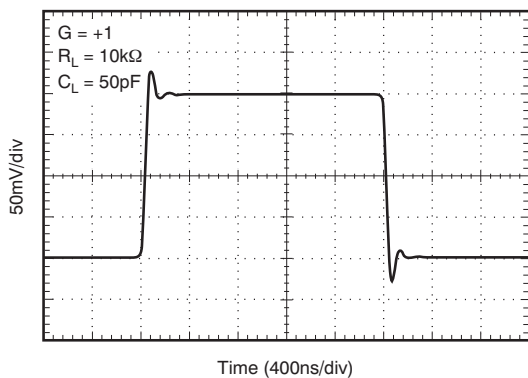

Figure 17.

LARGE-SIGNAL PULSE RESPONSE

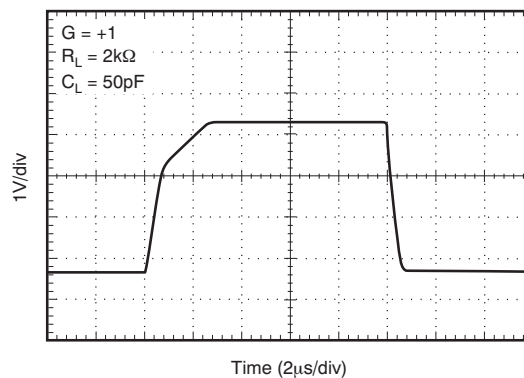

Figure 18.

TYPICAL CHARACTERISTICS (continued)

At $T_A = +25^\circ\text{C}$, $V_S = +5\text{V}$, $R_L = 10\text{k}\Omega$ connected to $V_S/2$, $V_{CM} = V_S/2$, and $V_{O_{UT}} = V_S/2$, unless otherwise noted.

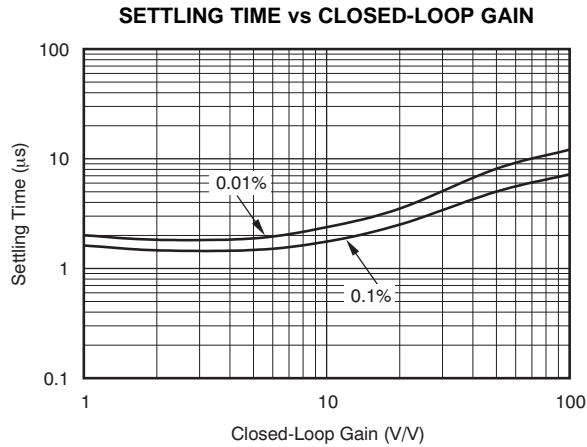

Figure 19.

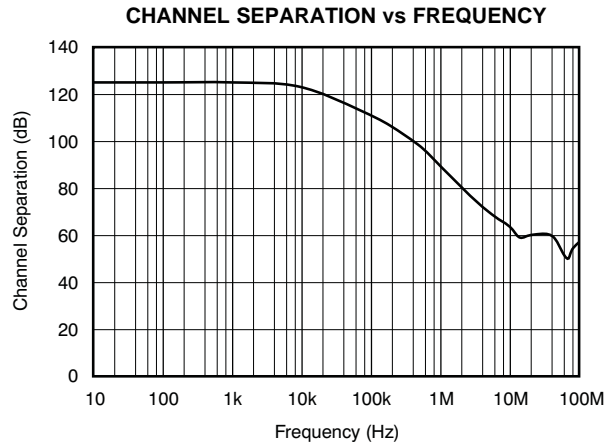

Figure 20.

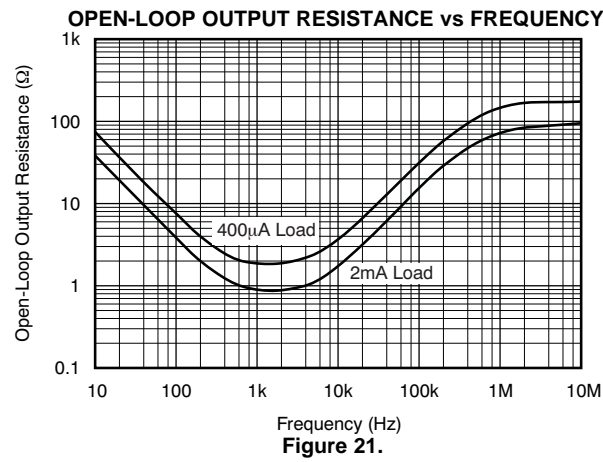

Figure 21.

APPLICATION INFORMATION

The OPA376-Q1 family of operational amplifiers is built using *e-trim*, a proprietary technique in which offset voltage is adjusted during the final steps of manufacturing. This technique compensates for performance shifts that can occur during the molding process. Through *e-trim*, the OPA376-Q1 family delivers excellent offset voltage (5 μ V, typ). Additionally, the amplifier boasts a fast slew rate, low drift, low noise, and excellent PSRR and A_{OL} . These 5.5MHz CMOS op amps operate on 760 μ A (typ) quiescent current.

OPERATING CHARACTERISTICS

The OPA376-Q1 family of amplifiers has parameters that are fully specified from 2.2V to 5.5V (± 1.1 V to ± 2.75 V). Many of the specifications apply from -40°C to $+125^{\circ}\text{C}$. Parameters that can exhibit significant variance with regard to operating voltage or temperature are presented in the [Typical Characteristics](#).

GENERAL LAYOUT GUIDELINES

For best operational performance of the device, good printed circuit board (PCB) layout practices are required. Low-loss, 0.1 μ F bypass capacitors must be connected between each supply pin and ground, placed as close to the device as possible. A single bypass capacitor from $V+$ to ground is applicable to single-supply applications.

BASIC AMPLIFIER CONFIGURATIONS

The OPA376-Q1 family is unity-gain stable. It does not exhibit output phase inversion when the input is overdriven. A typical single-supply connection is shown in [Figure 22](#). The OPA376-Q1 is configured as a basic inverting amplifier with a gain of -10V/V . This single-supply connection has an output centered on the common-mode voltage, V_{CM} . For the circuit shown, this voltage is 2.5V, but may be any value within the common-mode input voltage range.

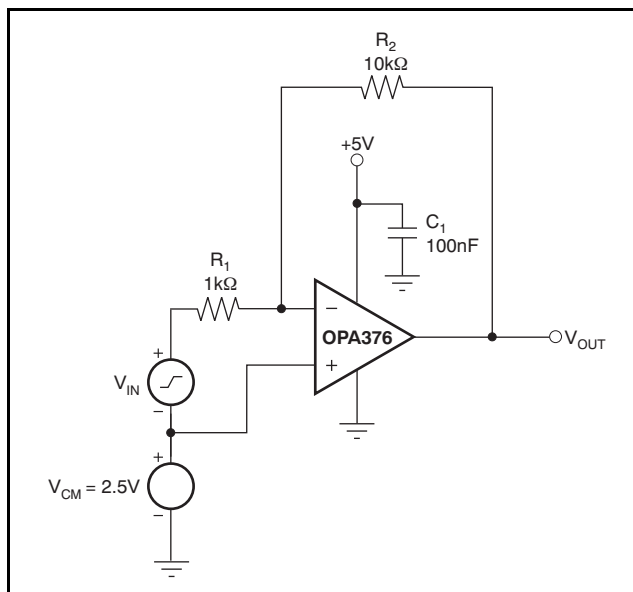

Figure 22. Basic Single-Supply Connection

COMMON-MODE VOLTAGE RANGE

The input common-mode voltage range of the OPA376-Q1 series extends 100mV beyond the supply rails. The offset voltage of the amplifier is very low, from approximately $(V-)$ to $(V+) - 1\text{V}$, as shown in [Figure 23](#). The offset voltage increases as common-mode voltage exceeds $(V+) - 1\text{V}$. Common-mode rejection is specified from $(V-)$ to $(V+) - 1.3\text{V}$.

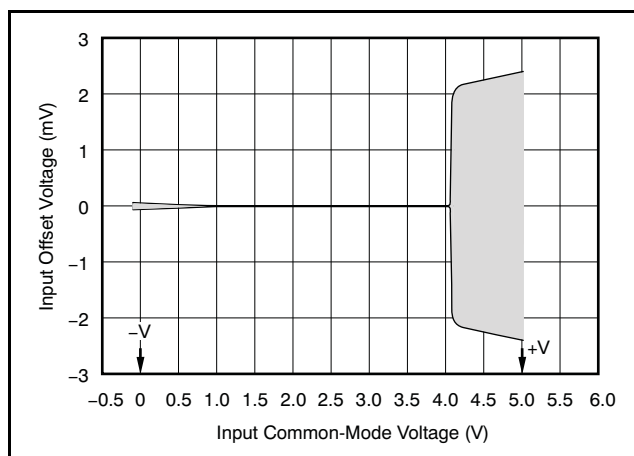

Figure 23. Offset and Common-Mode Voltage

INPUT AND ESD PROTECTION

The OPA376-Q1 family incorporates internal electrostatic discharge (ESD) protection circuits on all pins. In the case of input and output pins, this protection primarily consists of current steering diodes connected between the input and power-supply pins. These ESD protection diodes also provide in-circuit, input overdrive protection, as long as the current is limited to 10mA as stated in the [Absolute Maximum Ratings](#). Figure 24 shows how a series input resistor may be added to the driven input to limit the input current. The added resistor contributes thermal noise at the amplifier input and its value should be kept to a minimum in noise-sensitive applications.

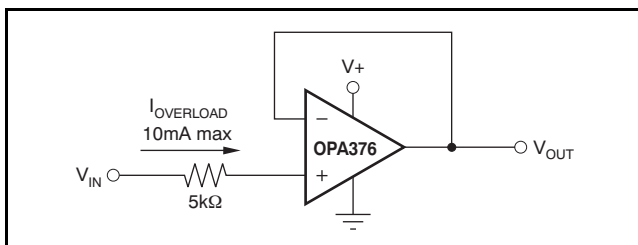

Figure 24. Input Current Protection

CAPACITIVE LOAD AND STABILITY

The OPA376-Q1 series of amplifiers may be used in applications where driving a capacitive load is required. As with all op amps, there may be specific instances where the OPAx376 can become unstable, leading to oscillation. The particular op amp circuit configuration, layout, gain, and output loading are some of the factors to consider when establishing whether an amplifier will be stable in operation. An op amp in the unity-gain (+1V/V) buffer configuration and driving a capacitive load exhibits a greater tendency to be unstable than an amplifier operated at a higher noise gain. The capacitive load, in conjunction with the op amp output resistance, creates a pole within the feedback loop that degrades the phase margin. The degradation of the phase margin increases as the capacitive loading increases.

The OPAx376 in a unity-gain configuration can directly drive up to 250pF pure capacitive load. Increasing the gain enhances the ability of the amplifier to drive greater capacitive loads; see the typical characteristic plot, [Small-Signal Overshoot vs Capacitive Load](#). In unity-gain configurations, capacitive load drive can be improved by inserting a small (10Ω to 20Ω) resistor, R_S , in series with the output, as shown in Figure 25. This resistor significantly reduces ringing while maintaining dc performance for purely capacitive loads. However, if there is a resistive load in parallel with the capacitive

load, a voltage divider is created, introducing a gain error at the output and slightly reducing the output swing. The error introduced is proportional to the ratio R_S/R_L , and is generally negligible at low output current levels.

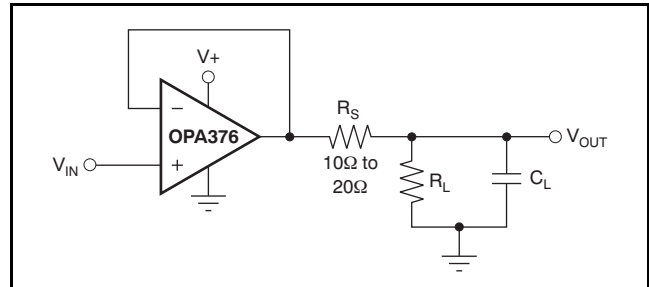

Figure 25. Improving Capacitive Load Drive

ACTIVE FILTERING

The OPA376-Q1 series is well-suited for filter applications requiring a wide bandwidth, fast slew rate, low-noise, single-supply operational amplifier. Figure 26 shows a 50kHz, 2nd-order, low-pass filter. The components have been selected to provide a maximally-flat Butterworth response. Beyond the cutoff frequency, roll-off is -40dB/dec. The Butterworth response is ideal for applications requiring predictable gain characteristics such as the anti-aliasing filter used ahead of an analog-to-digital converter (ADC).

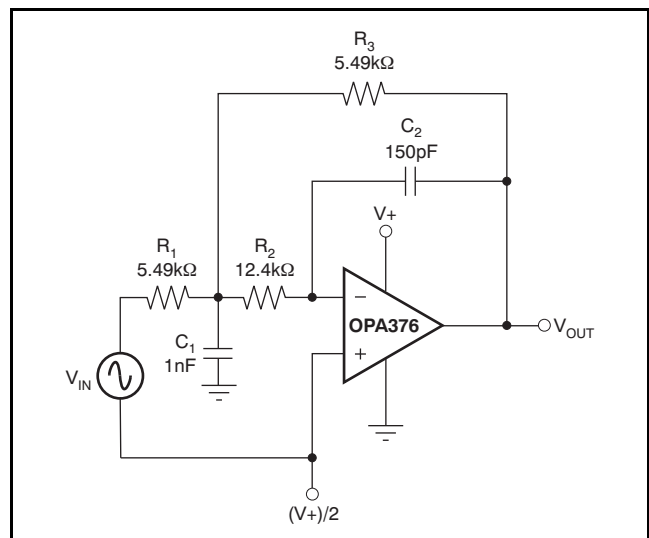

Figure 26. Second-Order Butterworth 50kHz Low-Pass Filter

PHOTOSENSITIVITY

Although the OPA2376YZD package has a protective backside coating that reduces the amount of light exposure on the die, unless fully shielded, ambient light can reach the active region of the device. Input

bias current for the package is specified in the absence of light. Depending on the amount of light exposure in a given application, an increase in bias current, and possible increases in offset voltage should be expected. Fluorescent lighting may introduce noise or hum because of the time-varying light output. Best layout practices include end-product packaging that provides shielding from possible light sources during operation.

DRIVING AN ANALOG-TO-DIGITAL CONVERTER

The low noise and wide gain bandwidth of the OPA376-Q1 family make it an ideal driver for ADCs. Figure 27 illustrates the OPA376-Q1 driving an ADS8327, 16-bit, 250kSPS converter. The amplifier is connected as a unity-gain, noninverting buffer.

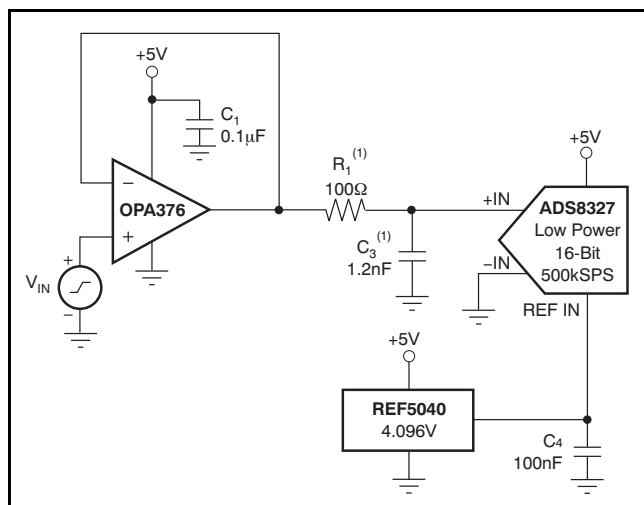

NOTE: (1) Suggested value; may require adjustment based on specific application.

Figure 27. Driving an ADS8327

PHANTOM-POWERED MICROPHONE

The circuit shown in Figure 28 depicts how a remote microphone amplifier can be powered by a phantom source on the output side of the signal cable. The cable serves double duty, carrying both the differential output signal from and dc power to the microphone amplifier stage.

An OPA2376-Q1 serves as a single-ended input to a differential output amplifier with a 6dB gain. Common-mode bias for the two op amps is provided by the dc voltage developed across the electret microphone element. A 48V phantom supply is reduced to 5.1V by the series 6.8kΩ resistors on the output side of the cable, and the 4.7kΩ and zener diode on the input side of the cable. AC coupling blocks the different dc voltage levels from each other on each end of the cable.

An **INA163** instrumentation amplifier provides differential inputs and receives the balanced audio signals from the cable.

The **INA163** gain may be set from 0dB to 80dB by selecting the R_G value. The **INA163** circuit is typical of the input circuitry used in mixing consoles.

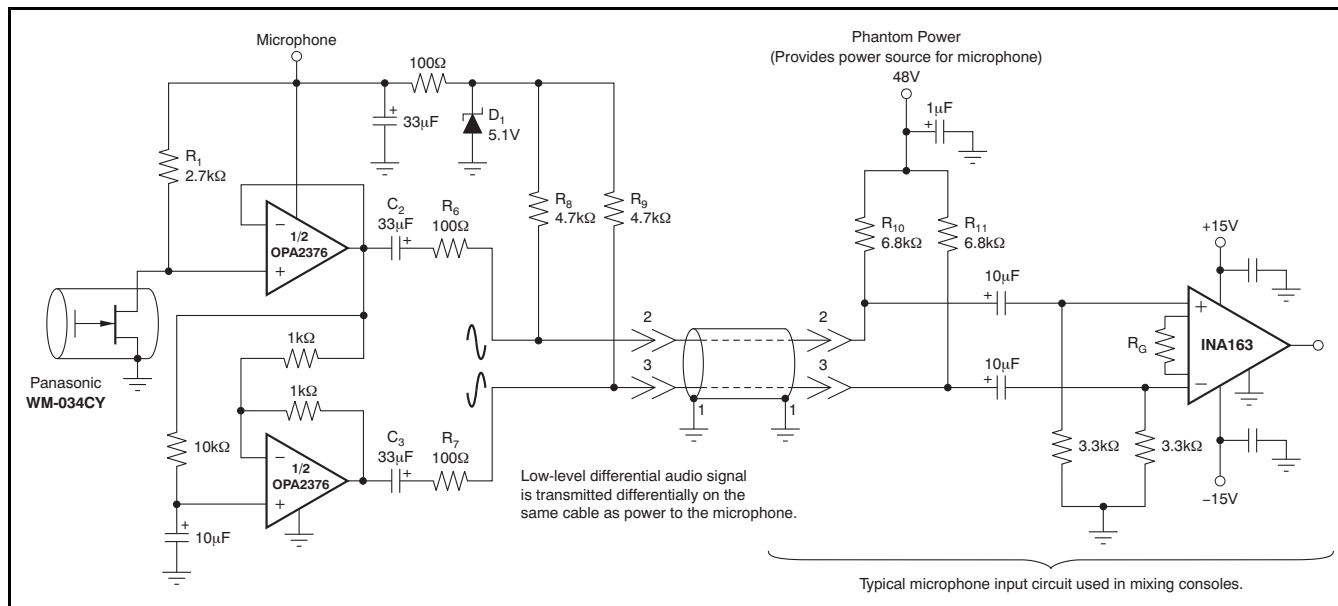
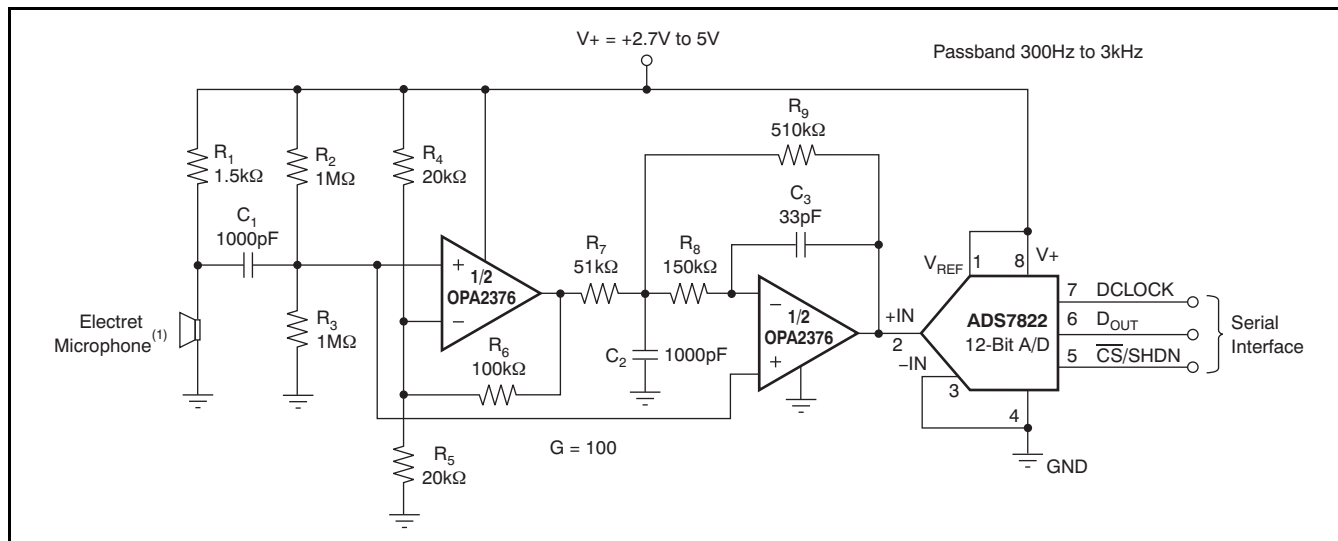

Figure 28. Phantom-Powered Electret Microphone



NOTE: (1) Electret microphone powered by R_1 .

Figure 29. OPA2376-Q1 as a Speech Bandpass Filtered Data Acquisition System

PACKAGING INFORMATION

Orderable Device	Status ⁽¹⁾	Package Type	Package Drawing	Pins	Package Qty	Eco Plan ⁽²⁾	Lead/ Ball Finish	MSL Peak Temp ⁽³⁾	Samples (Requires Login)
OPA376AQDBVRQ1	ACTIVE	SOT-23	DBV	5	3000	TBD	Call TI	Call TI	

⁽¹⁾ The marketing status values are defined as follows:

ACTIVE: Product device recommended for new designs.

LIFEBUY: TI has announced that the device will be discontinued, and a lifetime-buy period is in effect.

NRND: Not recommended for new designs. Device is in production to support existing customers, but TI does not recommend using this part in a new design.

PREVIEW: Device has been announced but is not in production. Samples may or may not be available.

OBSELETE: TI has discontinued the production of the device.

⁽²⁾ Eco Plan - The planned eco-friendly classification: Pb-Free (RoHS), Pb-Free (RoHS Exempt), or Green (RoHS & no Sb/Br) - please check <http://www.ti.com/productcontent> for the latest availability information and additional product content details.

TBD: The Pb-Free/Green conversion plan has not been defined.

Pb-Free (RoHS): TI's terms "Lead-Free" or "Pb-Free" mean semiconductor products that are compatible with the current RoHS requirements for all 6 substances, including the requirement that lead not exceed 0.1% by weight in homogeneous materials. Where designed to be soldered at high temperatures, TI Pb-Free products are suitable for use in specified lead-free processes.

Pb-Free (RoHS Exempt): This component has a RoHS exemption for either 1) lead-based flip-chip solder bumps used between the die and package, or 2) lead-based die adhesive used between the die and leadframe. The component is otherwise considered Pb-Free (RoHS compatible) as defined above.

Green (RoHS & no Sb/Br): TI defines "Green" to mean Pb-Free (RoHS compatible), and free of Bromine (Br) and Antimony (Sb) based flame retardants (Br or Sb do not exceed 0.1% by weight in homogeneous material)

⁽³⁾ MSL, Peak Temp. -- The Moisture Sensitivity Level rating according to the JEDEC industry standard classifications, and peak solder temperature.

Important Information and Disclaimer: The information provided on this page represents TI's knowledge and belief as of the date that it is provided. TI bases its knowledge and belief on information provided by third parties, and makes no representation or warranty as to the accuracy of such information. Efforts are underway to better integrate information from third parties. TI has taken and continues to take reasonable steps to provide representative and accurate information but may not have conducted destructive testing or chemical analysis on incoming materials and chemicals. TI and TI suppliers consider certain information to be proprietary, and thus CAS numbers and other limited information may not be available for release.

In no event shall TI's liability arising out of such information exceed the total purchase price of the TI part(s) at issue in this document sold by TI to Customer on an annual basis.

OTHER QUALIFIED VERSIONS OF OPA376-Q1 :

- Catalog: [OPA376](#)

NOTE: Qualified Version Definitions:

- Catalog - TI's standard catalog product

IMPORTANT NOTICE

Texas Instruments Incorporated and its subsidiaries (TI) reserve the right to make corrections, modifications, enhancements, improvements, and other changes to its products and services at any time and to discontinue any product or service without notice. Customers should obtain the latest relevant information before placing orders and should verify that such information is current and complete. All products are sold subject to TI's terms and conditions of sale supplied at the time of order acknowledgment.

TI warrants performance of its hardware products to the specifications applicable at the time of sale in accordance with TI's standard warranty. Testing and other quality control techniques are used to the extent TI deems necessary to support this warranty. Except where mandated by government requirements, testing of all parameters of each product is not necessarily performed.

TI assumes no liability for applications assistance or customer product design. Customers are responsible for their products and applications using TI components. To minimize the risks associated with customer products and applications, customers should provide adequate design and operating safeguards.

TI does not warrant or represent that any license, either express or implied, is granted under any TI patent right, copyright, mask work right, or other TI intellectual property right relating to any combination, machine, or process in which TI products or services are used. Information published by TI regarding third-party products or services does not constitute a license from TI to use such products or services or a warranty or endorsement thereof. Use of such information may require a license from a third party under the patents or other intellectual property of the third party, or a license from TI under the patents or other intellectual property of TI.

Reproduction of TI information in TI data books or data sheets is permissible only if reproduction is without alteration and is accompanied by all associated warranties, conditions, limitations, and notices. Reproduction of this information with alteration is an unfair and deceptive business practice. TI is not responsible or liable for such altered documentation. Information of third parties may be subject to additional restrictions.

Resale of TI products or services with statements different from or beyond the parameters stated by TI for that product or service voids all express and any implied warranties for the associated TI product or service and is an unfair and deceptive business practice. TI is not responsible or liable for any such statements.

TI products are not authorized for use in safety-critical applications (such as life support) where a failure of the TI product would reasonably be expected to cause severe personal injury or death, unless officers of the parties have executed an agreement specifically governing such use. Buyers represent that they have all necessary expertise in the safety and regulatory ramifications of their applications, and acknowledge and agree that they are solely responsible for all legal, regulatory and safety-related requirements concerning their products and any use of TI products in such safety-critical applications, notwithstanding any applications-related information or support that may be provided by TI. Further, Buyers must fully indemnify TI and its representatives against any damages arising out of the use of TI products in such safety-critical applications.

TI products are neither designed nor intended for use in military/aerospace applications or environments unless the TI products are specifically designated by TI as military-grade or "enhanced plastic." Only products designated by TI as military-grade meet military specifications. Buyers acknowledge and agree that any such use of TI products which TI has not designated as military-grade is solely at the Buyer's risk, and that they are solely responsible for compliance with all legal and regulatory requirements in connection with such use.

TI products are neither designed nor intended for use in automotive applications or environments unless the specific TI products are designated by TI as compliant with ISO/TS 16949 requirements. Buyers acknowledge and agree that, if they use any non-designated products in automotive applications, TI will not be responsible for any failure to meet such requirements.

Following are URLs where you can obtain information on other Texas Instruments products and application solutions:

Products

Audio	www.ti.com/audio
Amplifiers	amplifier.ti.com
Data Converters	dataconverter.ti.com
DLP® Products	www.dlp.com
DSP	dsp.ti.com
Clocks and Timers	www.ti.com/clocks
Interface	interface.ti.com
Logic	logic.ti.com
Power Mgmt	power.ti.com
Microcontrollers	microcontroller.ti.com
RFID	www.ti-rfid.com
RF/IF and ZigBee® Solutions	www.ti.com/lprf

Applications

Communications and Telecom	www.ti.com/communications
Computers and Peripherals	www.ti.com/computers
Consumer Electronics	www.ti.com/consumer-apps
Energy and Lighting	www.ti.com/energy
Industrial	www.ti.com/industrial
Medical	www.ti.com/medical
Security	www.ti.com/security
Space, Avionics and Defense	www.ti.com/space-avionics-defense
Transportation and Automotive	www.ti.com/automotive
Video and Imaging	www.ti.com/video
Wireless	www.ti.com/wireless-apps

TI E2E Community Home Page

e2e.ti.com

Mailing Address: Texas Instruments, Post Office Box 655303, Dallas, Texas 75265
Copyright © 2011, Texas Instruments Incorporated